

LUTHER SERIES

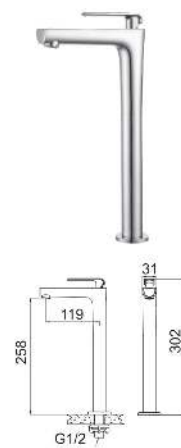

115.06101

CP brass basin pillar tap with quarter turn single lever handle.



115.10101

CP brass tall basin pillar tap with quarter turn single lever handle.

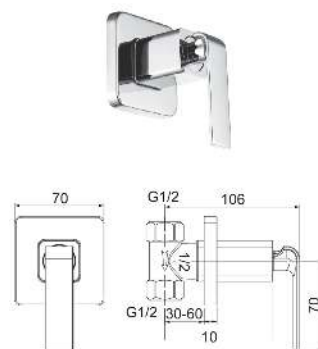

115.03101

CP brass 1/2" concealed stopcock with quarter turn single lever handle and sliding wall flange.



115.07101

CP brass pillar sink tap with quarter turn single lever handle and swivel spout.



115.08101

CP brass wall mounted sink tap with quarter turn single lever handle, swivel spout and wall flange.



115.11101

CP brass 1/2" angle valve with quarter turn single lever handle and sliding wall flange.



115.12101

CP brass wall mounted two way tap with quarter turn single lever handle and wall flange.



115.13101

CP brass wall mounted bib tap with quarter turn single lever handle and wall flange.

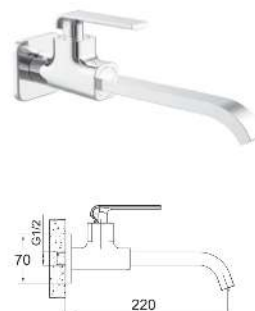

115.09101

CP brass wall mounted basin tap with quarter turn single lever handle and wall flange.

AGROW
Faucet

AKRON[®]
Faucet

DELUXE COLD TAP SERIES

- YATU
- LIMA
- LUTHER



AGROW CORPORATION SDN BHD
(COMPANY NO: 367036-I)

☎ 03- 78054748 (HUNTING LINE)

☎ 03- 78054723

✉ akron@agrow.com.my

🌐 www.agrow.com.my

PENANG: ☎ 04- 2297461/ 2297063

☎ 04- 2297462

JOHOR: ☎ 07- 3532261/ 3532267

☎ 07- 3532254



YATU SERIES



191.01101
CP brass basin pillar tap with quarter turn single lever handle.

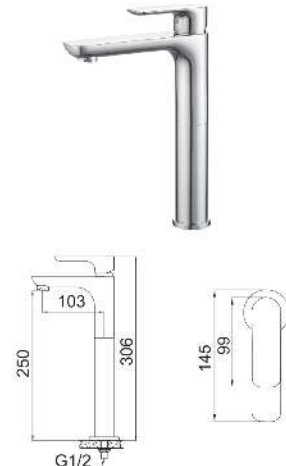

191.02101
CP brass tall basin pillar tap with quarter turn single lever handle.

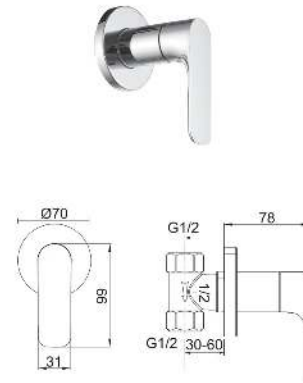

191.08101
CP brass 1/2" concealed stopcock with quarter turn single lever handle and sliding wall flange.

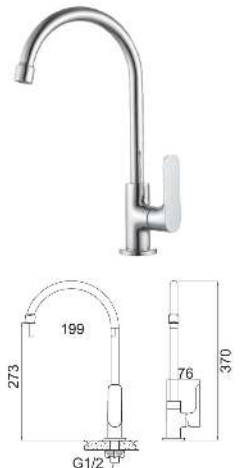

191.03101
CP brass pillar sink tap with quarter turn single lever handle and swivel spout.

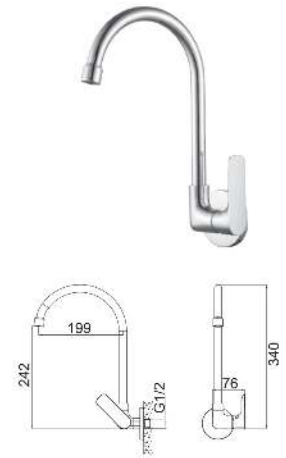

191.04101
CP brass wall mounted sink tap with quarter turn single lever handle, swivel spout and wall flange.



191.09101
CP brass 1/2" angle valve with quarter turn single lever handle and wall flange.



191.06101
CP brass wall mounted two way tap with quarter turn single lever handle and wall flange.



191.07101
CP brass wall mounted bib tap with quarter turn single lever handle and wall flange.



191.05101
CP brass wall mounted basin tap with quarter turn single lever handle and wall flange.

LIMA SERIES



175.07101
CP brass basin pillar tap with quarter turn single lever handle.

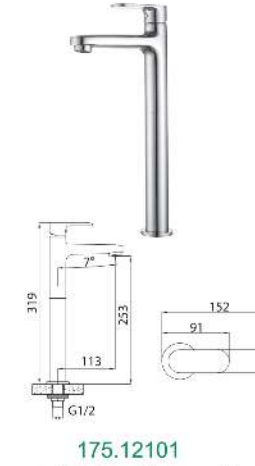

175.12101
CP brass tall basin pillar tap with quarter turn single lever handle.

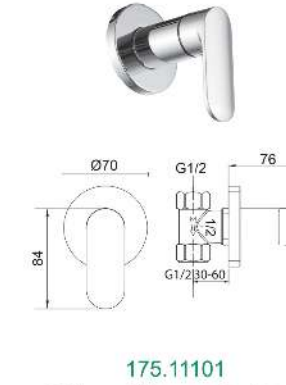

175.11101
CP brass 1/2" concealed stopcock with quarter turn single lever handle and sliding wall flange.



175.06101
CP brass pillar sink tap with quarter turn single lever handle and swivel spout.

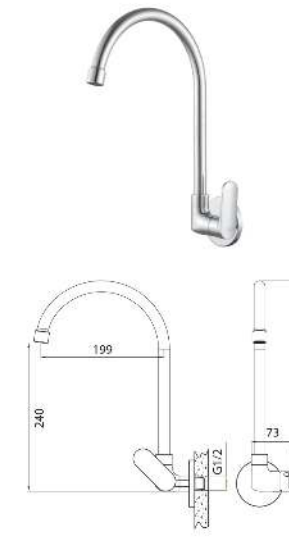

175.08101
CP brass wall mounted sink tap with quarter turn single lever handle, swivel spout and wall flange.

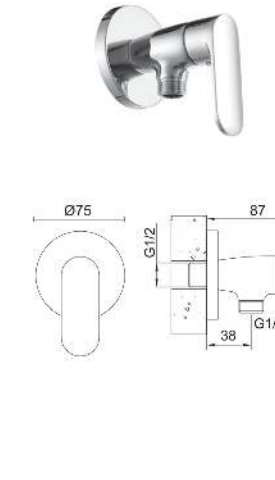

175.03101
CP brass 1/2" angle valve with quarter turn single lever handle and wall flange.



175.02101
CP brass wall mounted two way tap with quarter turn single lever handle and wall flange.



175.05101
CP brass wall mounted bib tap with quarter turn single lever handle and wall flange.



175.04101
CP brass wall mounted basin tap with quarter turn single lever handle and wall flange.

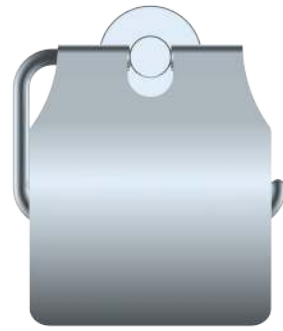

THE VISION OF SHAPES

GET INSPIRED SLOWLY
AND INEBRIATED SLOWLY
WHEN MUSIC SLOWLY FADES AWAY
YOU SAY
GOOD MORNING...

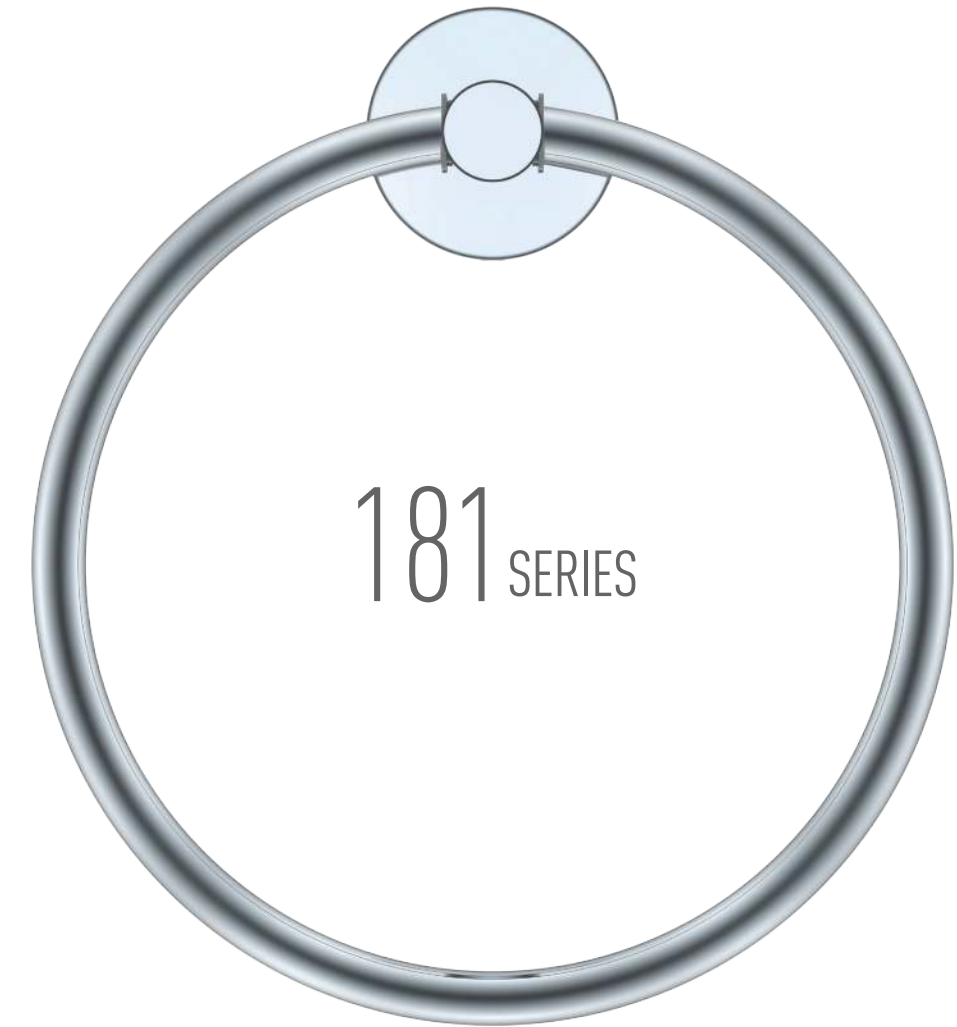
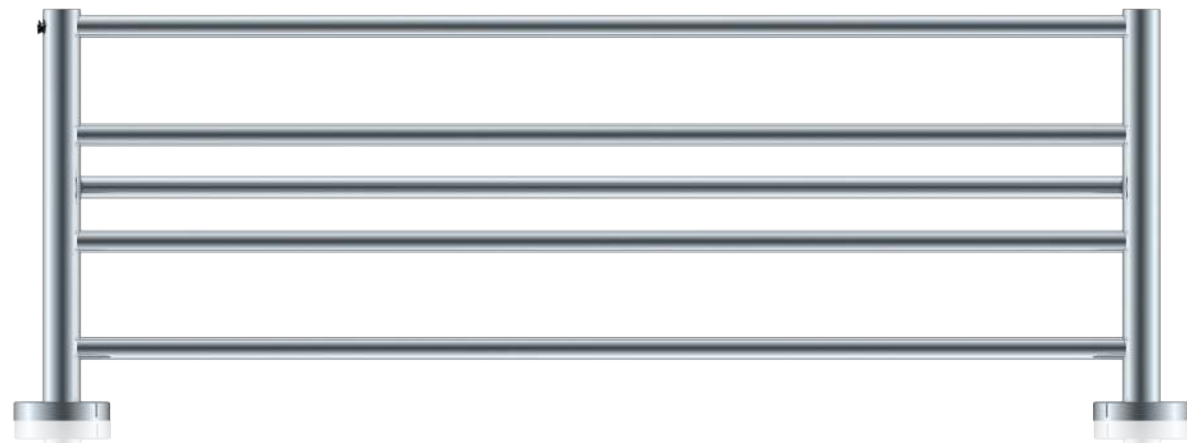

181 SERIES

181 SERIES



18103
Clothes hook
Material: Brass
Finish: Chrome

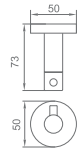

18104
Clothes hook
Material: Brass
Finish: Chrome

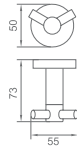

18106
Towel ring
Material: Brass
Finish: Chrome

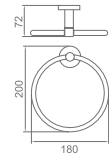

181101
Towel ring
Material: Brass
Finish: Chrome

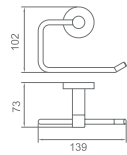

18101
Single cup holder
Material: Brass
Finish: Chrome

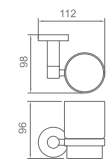

18102
Double cups holder
Material: Brass
Finish: Chrome

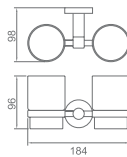

18107
Soap holder
Material: Brass
Finish: Chrome

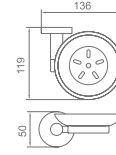

18108
Soap holder
Material: Brass
Finish: Chrome

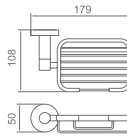

18110
Tissue holder
Material: Brass
Finish: Chrome

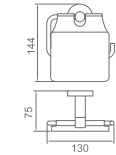

18109
Soap dispenser holder
Material: Brass
Finish: Chrome

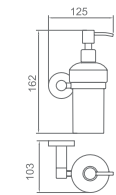

18105
Toilet brush holder
Material: Brass
Finish: Chrome

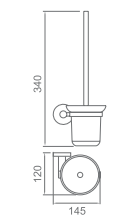

181141
Towel rack
Material: Brass
Finish: Chrome

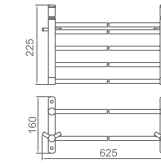

181142
Towel rack
Material: Brass
Finish: Chrome

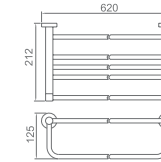

181143
Towel rack
Material: Brass
Finish: Chrome

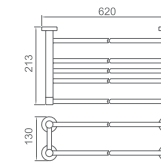

18114
Towel rack
Material: Brass
Finish: Chrome

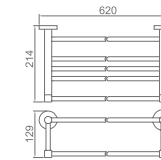

18111
Single towel bar
Material: Brass
Finish: Chrome



18112
Double towel bar
Material: Brass
Finish: Chrome

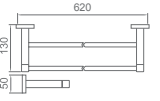

181151
Glass shelf
Material: Brass
Finish: Chrome



18119
Glass shelf
Material: Brass
Finish: Chrome

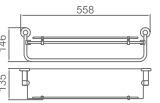

18118
Glass shelf
Material: Brass
Finish: Chrome

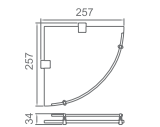

18116
Double glass shelf
Material: Brass
Finish: Chrome

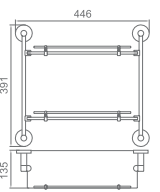

174 SERIES

MODERN SENSE

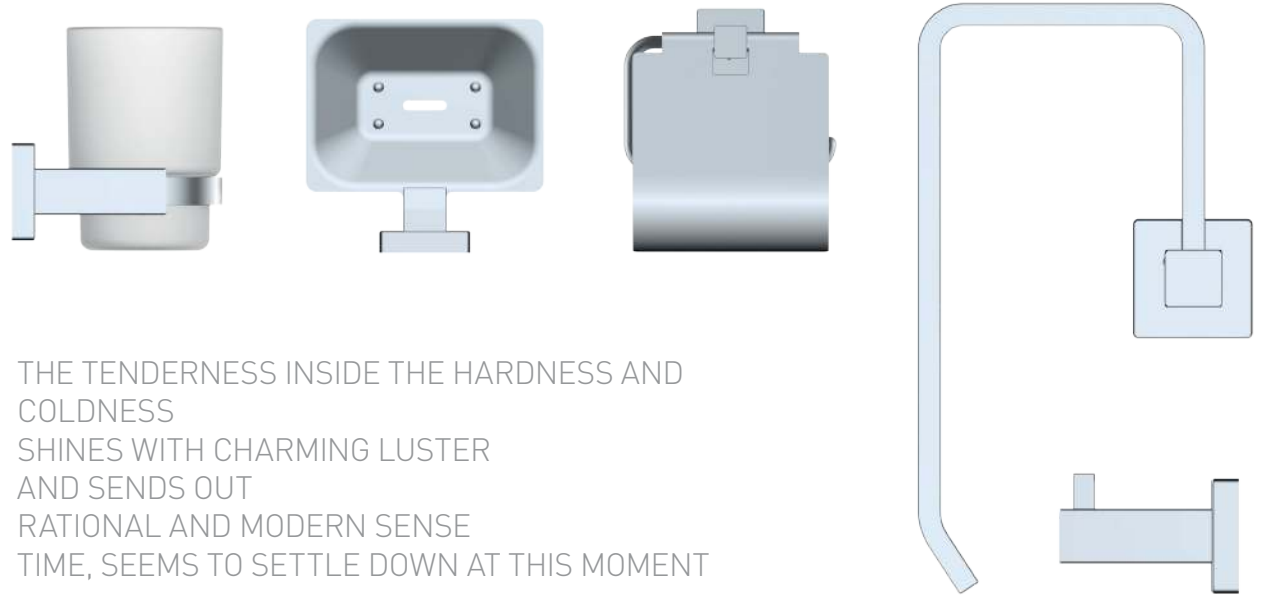

17418
Glass shelf
Material: Brass
Finish: Chrome

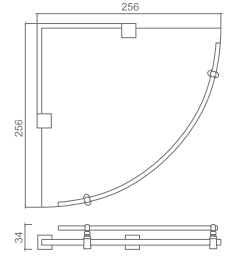

174151
Glass shelf
Material: Brass
Finish: Chrome

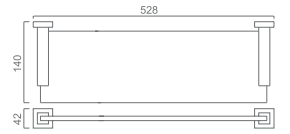

17416
Double glass shelf
Material: Brass
Finish: Chrome

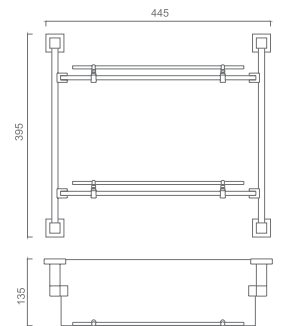

174 SERIES



17403
Clothes hook
Material: Brass
Finish: Chrome

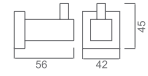

17407
Soap holder
Material: Brass
Finish: Chrome

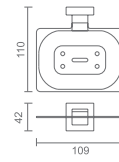

17414
Towel rack
Material: Brass
Finish: Chrome

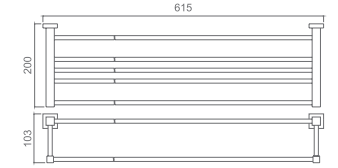

17406
Towel ring
Material: Brass
Finish: Chrome

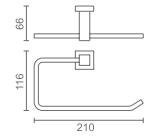

17410
Tissue holder
Material: Brass
Finish: Chrome

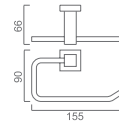

174141
Towel rack
Material: Brass
Finish: Chrome

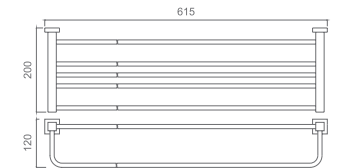

17409
Soap dispenser holder
Material: Brass
Finish: Chrome

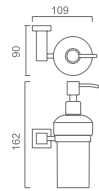

174101
Tissue holder
Material: Brass
Finish: Chrome

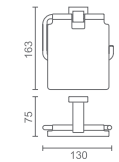

17412
Towel rack
Material: Brass
Finish: Chrome

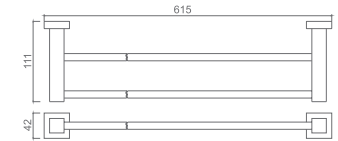

174011
Single cup holder
Material: Brass
Finish: Chrome

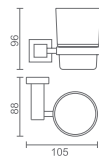

1741012
Tissue holder
Material: Brass
Finish: Chrome

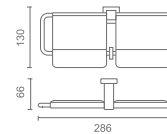

17402
Double cups holder
Material: Brass
Finish: Chrome

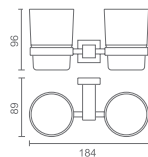

17405
Toilet brush holder
Material: Brass
Finish: Chrome

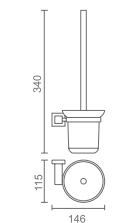

17411
Towel rack
Material: Brass
Finish: Chrome

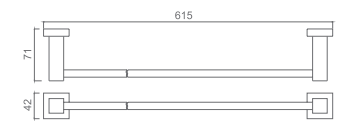

Nylon Coated Safety Grab Rail For The Needy



AKRON[®]

MEDI-CARE

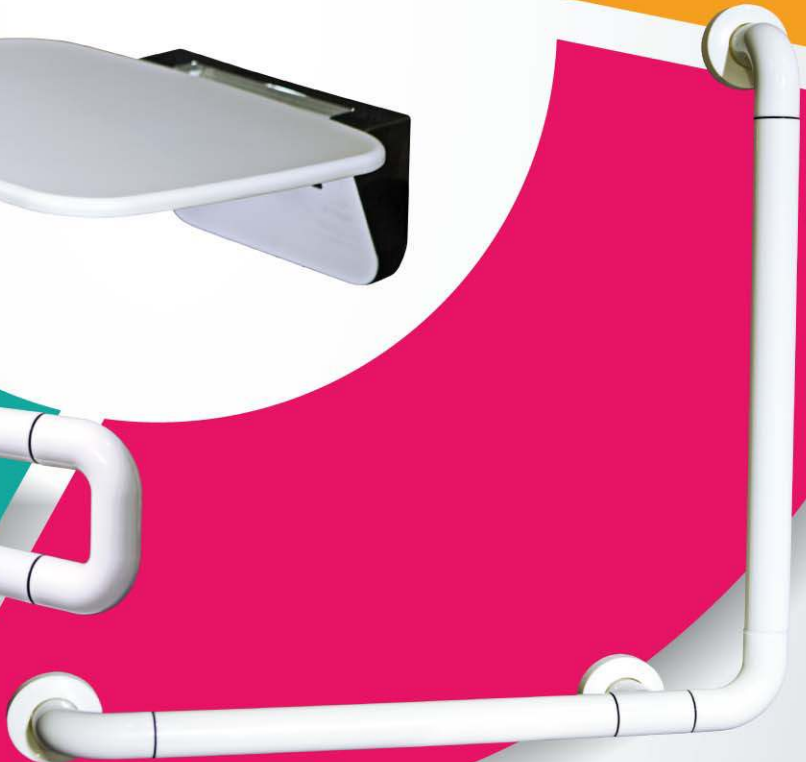

AKRON[®] MEDI-CARE Safety Grab Bars

(All in White)

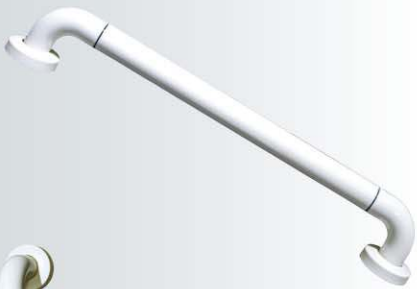

AGXY32-23

Straight grab bar with nylon coated aluminium core & stainless steel end bends, anti-bacteria coating. Unit c/w fixing set and roses for fixing to solid wall.

Dimension : Ø35mm x 600mm (end-to-end)

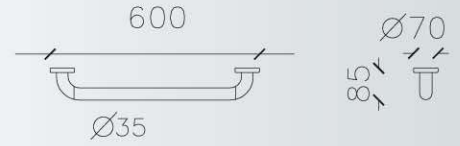

AGXY32-27 (Reversible)

L-Shaped grab bar with nylon coated aluminium core & stainless steel end bends, anti-bacteria coating. Unit c/w fixing set and roses for fixing to solid wall.

AGXY32-27

Dim : Ø35mm x 600mm x 600mm (end-to-end)

AGXY32-27-700

Dim : Ø35mm x 700mm x 700mm (end-to-end)

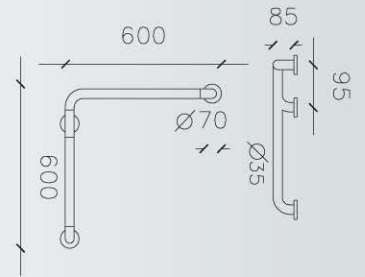

AGXY32-29-1

Folding grab bar with nylon coated aluminium core & stainless steel end bends, anti-bacteria coating. Can be folded upwards and with friction device downwards. Unit c/w CP metal supporting plate and fixing set for fixing to solid wall.

Dim : Ø35mm x 700mm

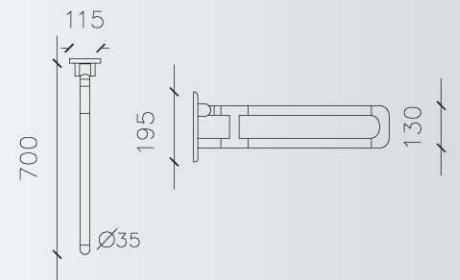

AGXY32-22 (Reversible)

Support grab bar with nylon coated aluminium core & stainless steel end bends, anti-bacteria coating. Unit c/w fixing set and roses for fixing to solid wall.

Dim : Ø35mm x 700mm

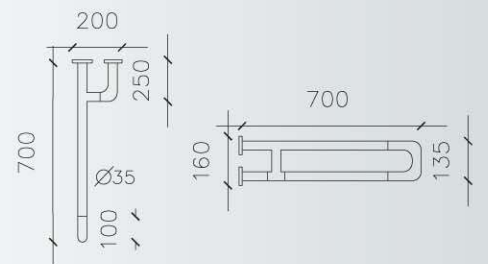

AGF187

Heavy duty urea shower seat with CP hinge and fixing set for fixing to solid wall.

Max. Loading : 160kg

Dim : W350mm x D275mm

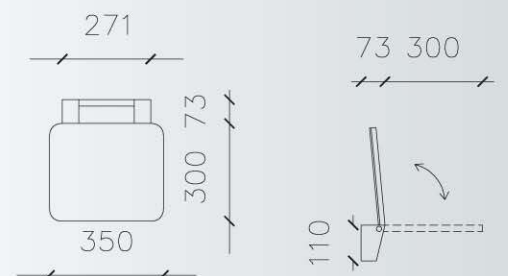

Since 1981

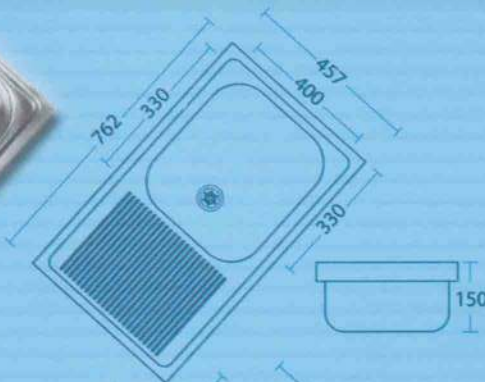

OKG 762 A (Lay-on)
OKG 762 B/C (Inset)
 Thickness : 0.6mm
 Depth : 150mm
 Bowl size : (330*400*150)mm

Waste size : 1.5" (Lay-on)
 3.5" (Inset)
 Orientation : Reversible
 External size : (762*457)mm

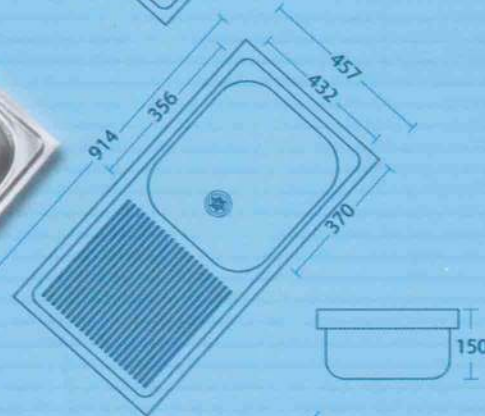

OKG 914 A (Lay-on)
OKG 914 B/C (Inset)
 Thickness : 0.6mm
 Depth : 150mm
 Bowl size : (356*432*150)mm

Waste size : 1.5" (Lay-on)
 3.5" (Inset)
 Orientation : Reversible
 External size : (914*457)mm

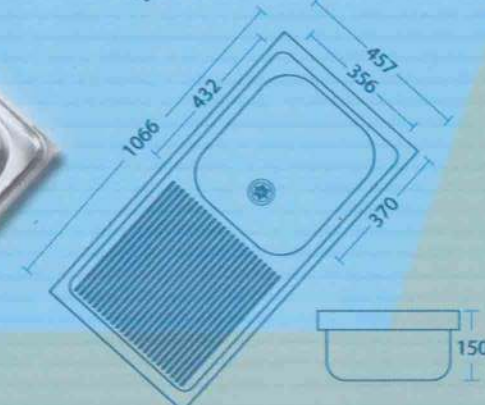

OKG 1066 A (Lay-on)
OKG 1066 B/C (Inset)
 Thickness : 0.6mm
 Depth : 150mm
 Bowl size : (356*432*150)mm

Waste size : 1.5" (Lay-on)
 3.5" (Inset)
 Orientation : Reversible
 External size : (1066*457)mm

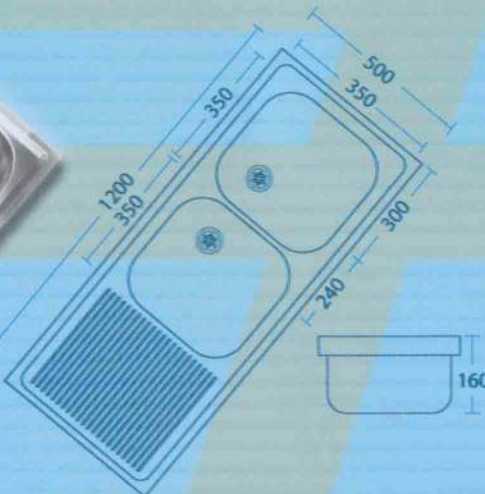

OKG 1250 A (Lay-on)
OKG 1250 A/C (Inset)
 Thickness : 0.6mm
 Depth : 160mm
 Bowl size : (350*350*150)mm

Waste size : 1.5"
 Orientation : Non Reversible
 External size : (1200*500)mm



3 1/2" Universal waste with overflow safety
 (Including clips for inset model)



1 1/2" waste with overflow safety



Lay-on model edge profile



Inset model edge profile

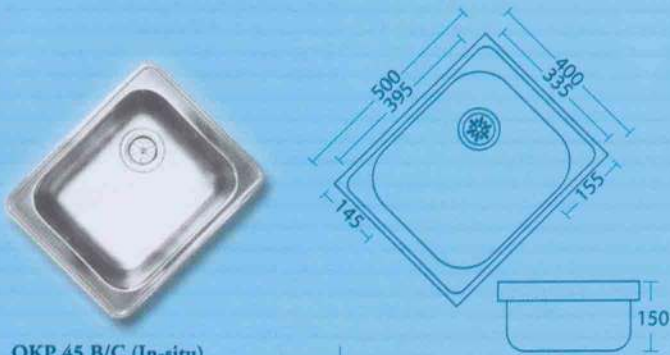

OKP 45 B/C (In-situ)

Thickness : 0.5mm
 Depth : 150mm
 Bowl size : (395*335*150)mm
 Orientation : Non Reversible
 Waste size : 3.5"
 External size : (500*400)mm



OKP 605 B/C (Inset)

Thickness : 0.6mm
 Depth : 150mm
 Bowl size : (540*390*150)mm
 Orientation : Non Reversible
 Waste size : 3.5"
 External size : (600*550)mm

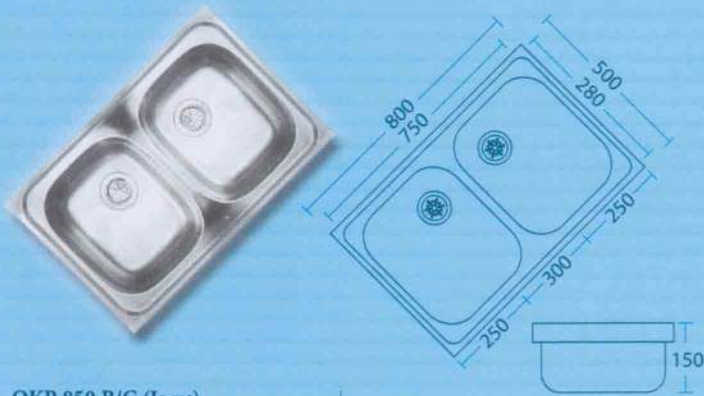

OKP 850 B/C (Inset)

Thickness : 0.6mm
 Depth : 150mm
 Bowl size : (330*380*150)mm
 Orientation : Non Reversible
 Waste size : 3.5"
 External size : (800*500)mm

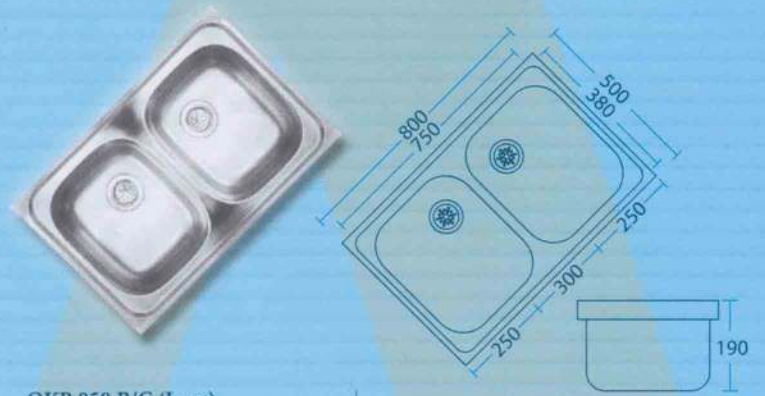

OKP 858 B/C (Inset)

Thickness : 0.8mm
 Depth : 190mm
 Bowl size : (330*380*190)mm
 Orientation : Non Reversible
 Waste size : 3.5"
 External size : (800*500)mm

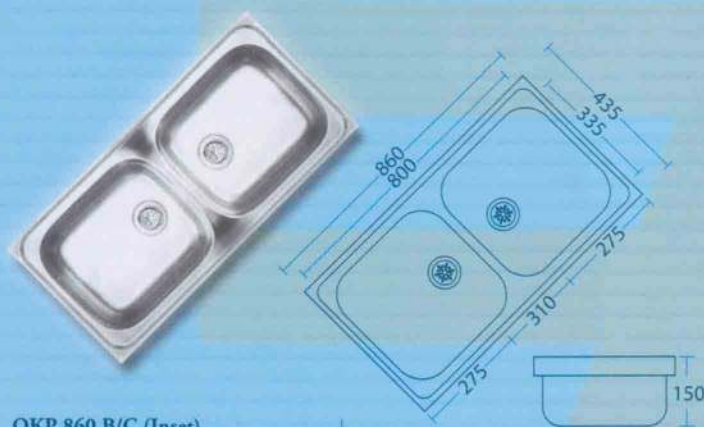

OKP 860 B/C (Inset)

Thickness : 0.6mm
 Depth : 150mm
 Bowl size : (365*335*150)mm
 Orientation : Reversible
 Waste size : 3.5"
 External size : (860*435)mm

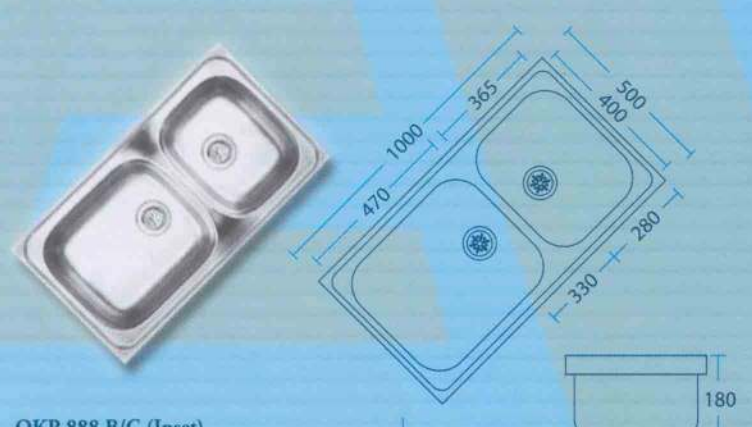

OKP 888 B/C (Inset)

Thickness : 0.8mm
 Depth : 180mm
 Bowl size : Small : (365*400*180)mm
 Big : (470*400*180)mm
 Orientation : Reversible
 Waste size : 3.5"
 External size : (1000*500)mm



3 1/2" Universal waste with overflow safety
 (Including clips for inset model)



1 1/2" waste with overflow safety

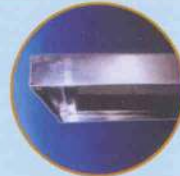

Lay-on model edge profile



Inset model edge profile

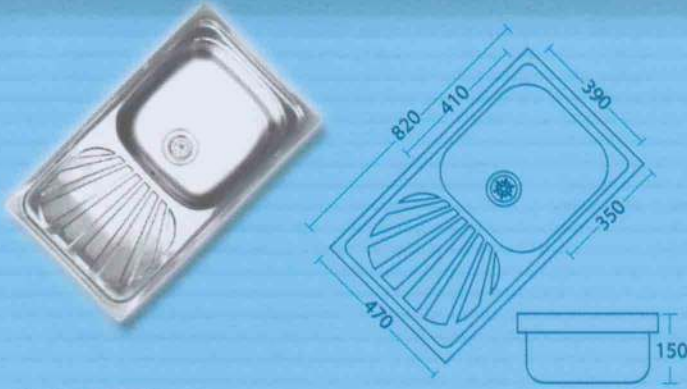

OKP 845 B/C (Inset)

Thickness : 0.6mm
 Depth : 150mm
 Bowl size : (410*390*150)mm

Orientation : Reversible
 Waste size : 3.5"
 External size : (820*470)mm

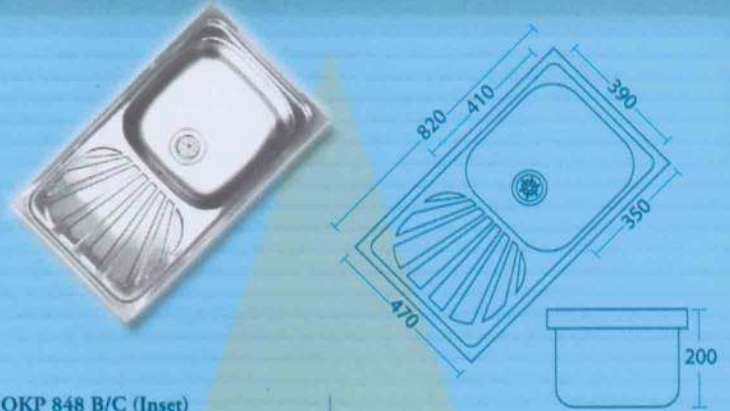

OKP 848 B/C (Inset)

Thickness : 0.8mm
 Depth : 200mm
 Bowl size : (410*390*200)mm

Orientation : Reversible
 Waste size : 3.5"
 External size : (820*470)mm

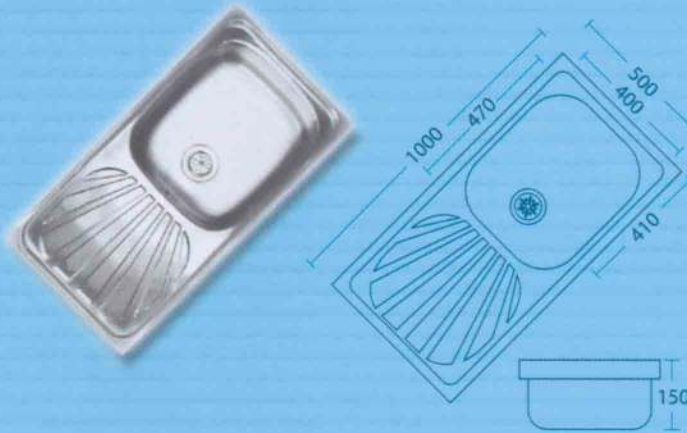

OKP 1050 B/C (Inset)

Thickness : 0.6mm
 Depth : 150mm
 Bowl size : (470*400*150)mm

Orientation : Reversible
 Waste size : 3.5"
 External size : (1000*500)mm



OKP 1058 B/C (Inset)

Thickness : 0.8mm
 Depth : 200mm
 Bowl size : (470*400*200)mm

Orientation : Non Reversible
 Waste size : 3.5"
 External size : (1000*500)mm

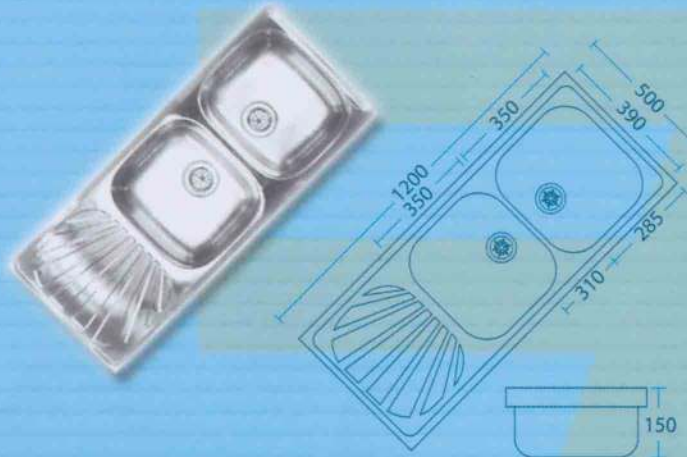

OKP 1250 B/C (Inset)

Thickness : 0.6mm
 Depth : 150mm
 Bowl size : (350*390*150)mm

Orientation : Reversible
 Waste size : 3.5"
 External size : (1200*500)mm

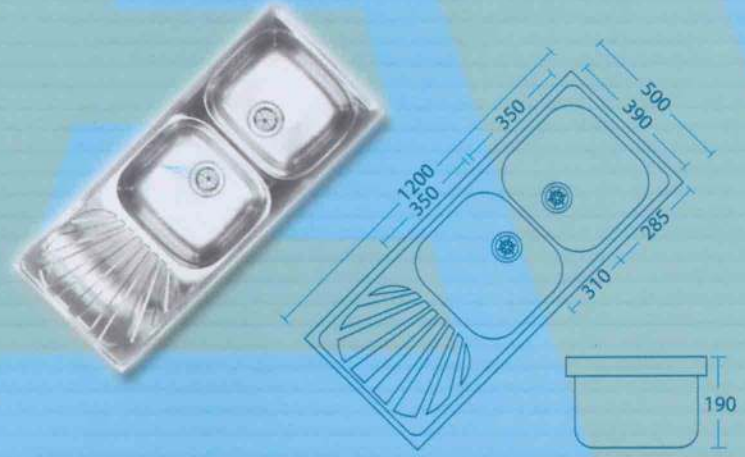

OKP 1258 B/C (Inset)

Thickness : 0.8mm
 Depth : 190mm
 Bowl size : (350*390*190)mm

Orientation : Reversible
 Waste size : 3.5"
 External size : (1200*500)mm

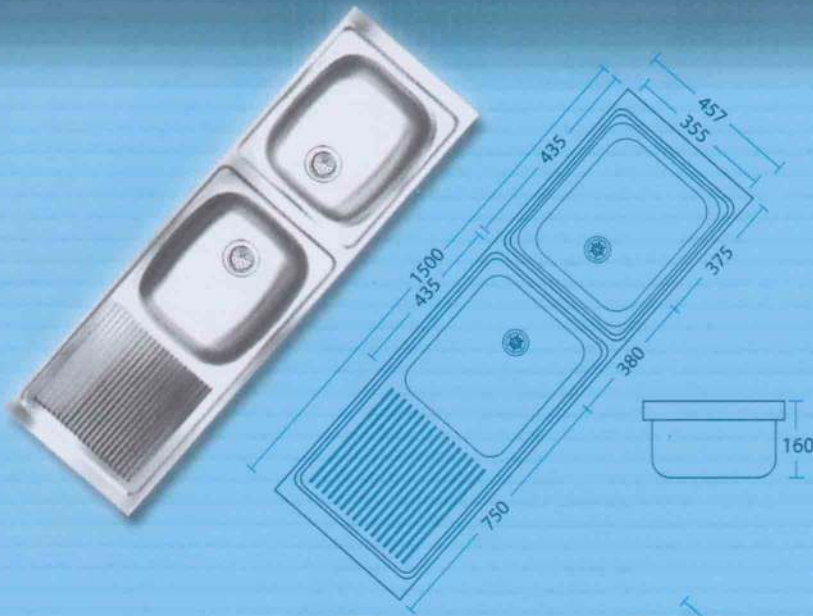

OKG 1500 DS (Lay-on)

Thickness : 0.6mm
 Depth : 160mm
 Bowl size : (435*355*160)mm

Waste size : 3.5"
 Orientation : Reversible
 External size : (1500*457)mm

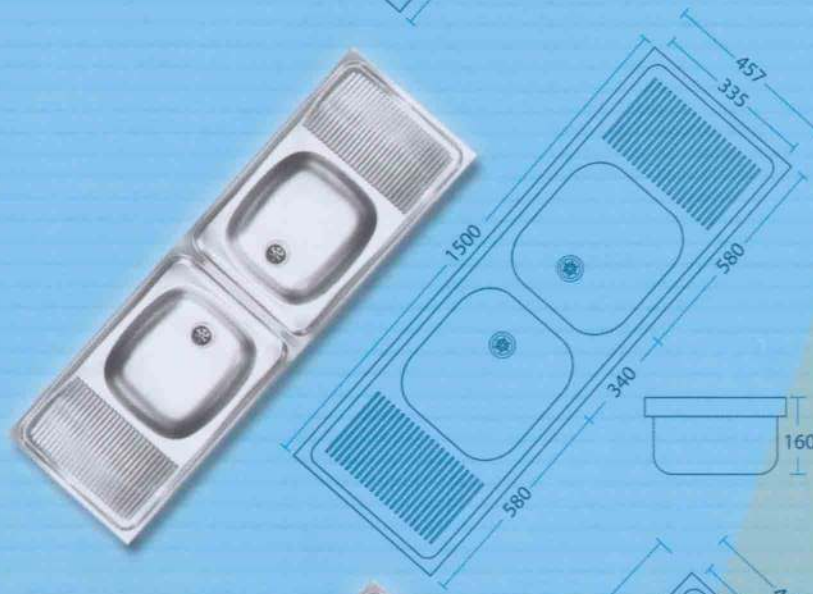

OKG 1500 DD (Lay-on)

Thickness : 0.6mm
 Depth : 160mm
 Bowl size : (400*335*160)mm

Waste size : 3.5"
 Orientation : Reversible
 External size : (1500*457)mm

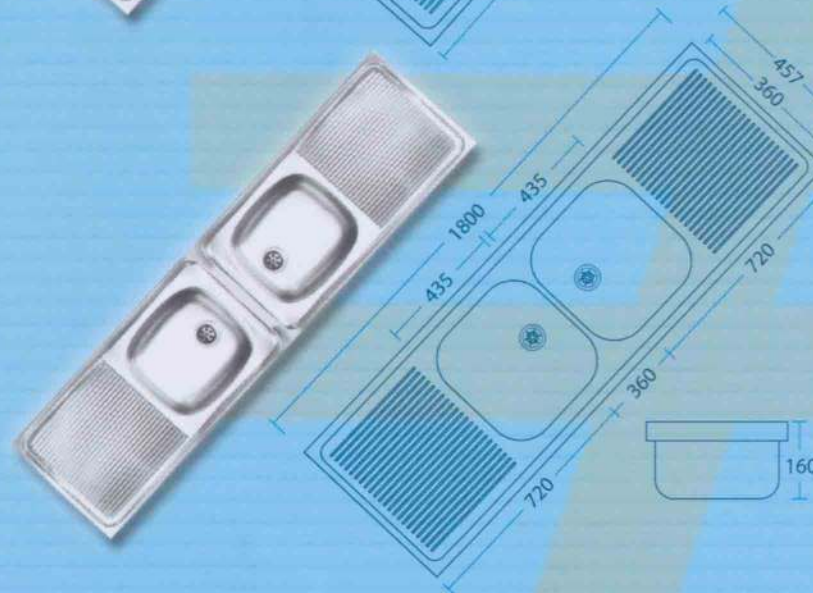

OKG 1800 DD (Lay-on)

Thickness : 0.6mm
 Depth : 160mm
 Bowl size : (435*360*160)mm

Waste size : 3.5"
 Orientation : Reversible
 External size : (1800*457)mm